

Technical Parameters

Print Functions	
Model	Kirin660X
Printing Method	Single Pass, Piezoelectric Inkjet
Color Capability	CMYK
Ink Type	Water-based Pigment
Color Modules	Front and Back (Monochrome, 2 Colors, 4 Colors (CMYK))
Max. Resolution	1200 * 1200 DPI
Max. Print Speed	150 m/min
Media Types	Coated Paper, Digital Paper, Matte Paper, Newsprint, Lightweight Paper, and Uncoated Paper
Transportation Method	Roll to Roll, Roll to stacks (optional)
Media Thickness	40 - 157 gsm (some papers require testing)
Printing Width	350 - 584 mm
Max. Material Width	660 mm
Max. Material Diameter	1270 mm
Power Requirements	
Power Supply	AC380V / 50Hz
Power Consumption	Printer: 35 kW, Dryer: 50 kW
Drying Method	Infrared Air Drying
Printer Dimensions	11150 * 2050 * 2060 mm (roll to stack) 8150 * 2050 * 2060 mm (roll to roll)
Working Environment	
Temperature	18 - 24
Constant Humidity	40 - 60%

Kirin660X

DIGITAL INKJET SOLUTION FOR BOOKS AND MAGAZINES

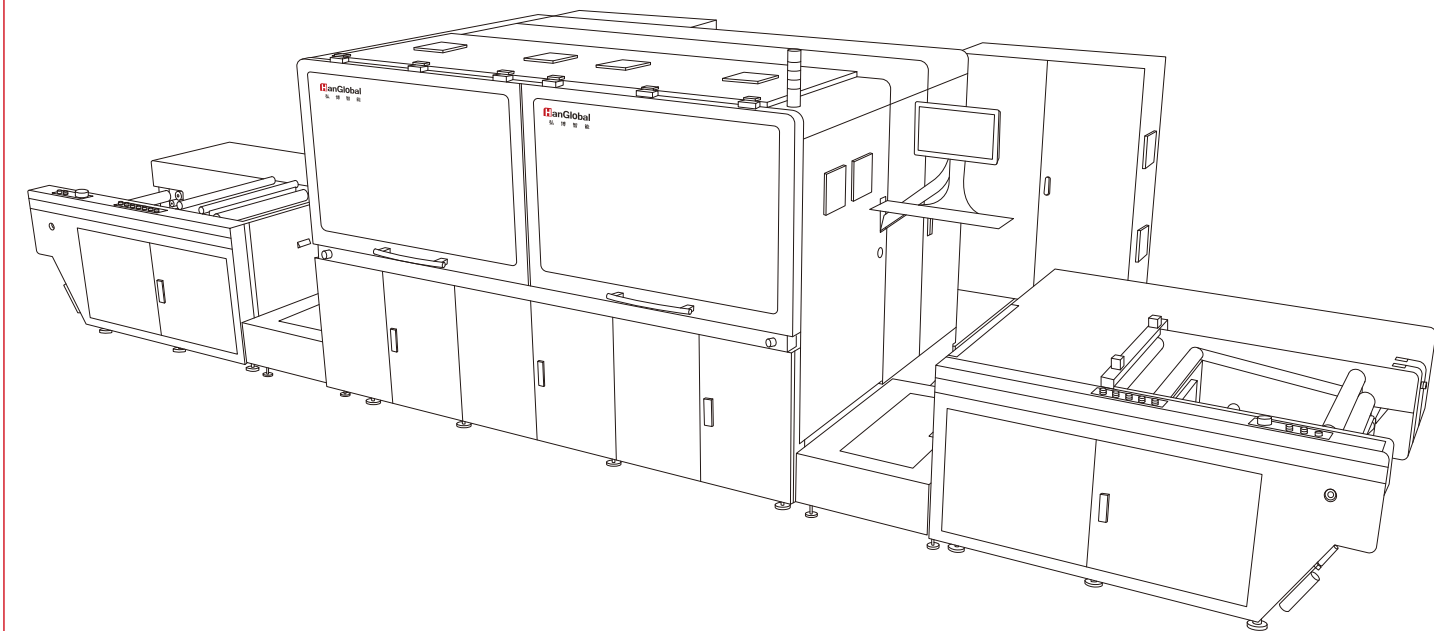

Full Product Lineup and Comprehensive Solution Design

Our comprehensive digital inkjet solution for books and magazines is tailored to meet the specific needs of commercial printing, print-on-demand (POD) publishing, government document printing, industrial manuals, and more.

Printing Width: 350 - 584 mm

Max. Print Speed: 150 m/min

Max. Resolution: 1200 * 1200 DPI



Shenzhen HanGlobal Digital Solutions Co., Ltd.

Add: No.39 Qingfeng Road, Baolong Street, Longgang District, Shenzhen
(2-3/F, Building C, Jingmida Digital Culture Industry Park - HanGlory Group)
Tel: +86 0755-23080896 **E-mail:** info@hanglorygroup.com
Fax: +86 0755-23217841 **Web:** www.hanglorygroup.com/en

©The above information is for reference only, Shenzhen HanGlobal Digital Solutions Co., Ltd. reserves the right of final interpretation, subject to change without notice, the final information subject to contract.

V2.0/2024

Kirin660X Comprehensive Solution for Digital Inkjet Printing of Books and Magazines

The ultimate solution for comprehensive digital inkjet printing of books and magazines. Designed to meet the demands of print-on-demand publishing, Government documentation, industrial manuals, and commercial printing worldwide.

Experience the power of Kirin660X's high-speed rotary inkjet technology, delivering mass production capabilities, exceptional print quality, and unmatched reliability. With Kirin660X, you can meet the challenges of batch production and personalized printing while achieving cost-effective results. Elevate your productivity, exceed customer's expectations, and embrace the future of digital printing with Kirin660X as your trusted partner.

Seamless Integrated Product-line

Revolutionize industrial book printing with our advanced solution that integrates roll feeding, precise printing, and efficient post-processing. Experience top-quality results and increased productivity as we redefine the industry with our cutting-edge technology and comprehensive solution.



Web Guide

- Internationally renowned web guiding devices, the system automatically corrects the paper alignment during operation, ensuring stable and consistent paper handling throughout the printing process.



Unwind

- Experience the precision and stability of our active unwinding method, driven by European servo control technology.
- The implementation of a multiple section tension control system ensures precise high-speed printing, while the use of web path revision instead of a turn bar guarantees stable tension throughout the process, ensuring consistent print quality.

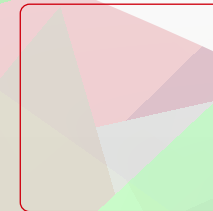

Printing Module

- High-resolution industrial-grade printheads operating at 1200 DPI, delivering excellent quality for text, graphics, and images.
- Real-time monitoring of every component in the inkjet printing system, ensuring optimal performance and efficiency.
- Independent electronic control, enabling individual adjustment of print-head alignment in the X and Y directions for fast setup and improved efficiency.
- Improve stability during continuous printing, even with prolonged use and high temperatures.



Sheeting and Stacking Module (Optional)

- Cutting, slitting, and booklet stacking functions are available as optional features.



Drying Module

- Powerful and efficient infrared drying system automatically adjusts with the printing speed, reducing energy consumption.
- The drying module ensures the required level of heat airflow during high-speed printing by utilizing a combination of cold and hot air, significantly enhancing drying efficiency.

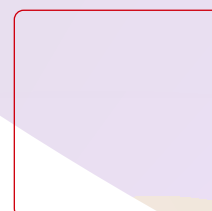

Web Reversing Mechanism

- By eliminating the need for a turn bar and utilizing our web reverse mechanism, we ensure consistent web tension and precise registration throughout the press.



Rewind Module

- Servo-controlled unwinding system ensures a more even and stable tension during the rewinding process.
- Our rewinding system ensures a neat and even winding of the printed paper, facilitating smooth handling and further processing in subsequent production stages.

Kirin660X Comprehensive Solution for Book and Magazine Digital Inkjet Printing Showcases the Following

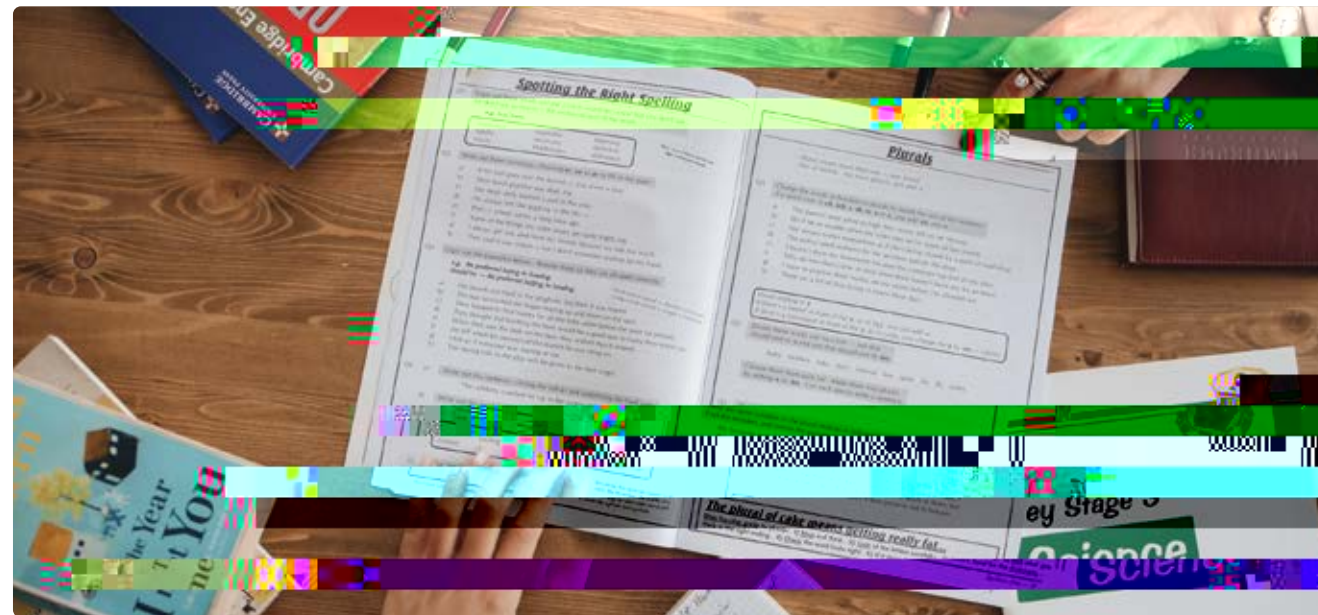

Key Highlights

Unleashes the Cost Benefits with Kirin660X

- Provides flexibility for short-run production, eliminating the need for plate-making and enabling on-demand printing. It is highly adaptable, catering to both large-scale production and small-batch customization needs.
- Reducing the reliance on skilled technicians, the Kirin660X solution reduces overall production, time, and personnel costs, achieving low or even zero inventory levels.
- Experience the stunning image quality and rapid development of new business opportunities with the Kirin660X, enabling effortless expansion of cost-effective on-demand printing for books and magazines with short turnaround times.

Remarkable Leap in Quality, Efficiency, and Stability with the Powerful Kirin660X

- Next-gen 1200DPI inkjet printing technology, reaching speeds up to 150m/min for unparalleled quality and efficiency.
- Achieve industry-leading print quality with a maximum resolution of 1200 * 1200DPI, comparable to offset printing, meeting the national standards for book and magazine printing quality.
- Experience the unrivaled power of our cutting-edge solution, featuring a high-resolution industrial print-head, integrated inkjet control system, and advanced tension control. With top-tier components and exceptional hardware and software capabilities, our solution ensures seamless and stable production for long-term success.

Strong Self-development Capabilities

- Complete ownership of the digital inkjet printing technology with independent intellectual property rights. Own control software, mechanical platform, inkjet system, and other core hardware and software components.
- Collaborating with leading printhead manufacturers and leveraging over a decade of experience in high-speed industrial-grade printhead research and utilization, we have mastered the core printhead driving technology, enabling exceptional inkjet performance.
- Self-developed quick-drying CMYK inks deliver fast drying speed, enhanced image resolution, sharper text, and wider paper compatibility. They not only meet strict environmental standards but also produce vibrant colors that closely rival the color gamut of offset printing inks. With our independent ink supply chain, we are committed to fostering a flourishing ecosystem for the inkjet industry.

Comprehensive Solution Capability

Provide end-to-end comprehensive solutions covering pre-press preparation, printing, cutting, ink supply, and more, ensuring a seamless workflow from start to finish.

- Standard: Roll to Roll / Optional: Roll to Stack
- Wide Range of Materials: Wide range of paper types, including coated paper, digital paper, newsprint, lightweight paper, and uncoated paper, without the need for additional coating. It supports a paper weight range of 40 to 157g, ensuring versatility and flexibility in print applications.
- Catering to Customers: Publishing houses, printing factories, pre-press companies, graphic production and processing centers, and large to medium-sized graphic and printing shops.

The solution is suitable for various printing scenarios, including

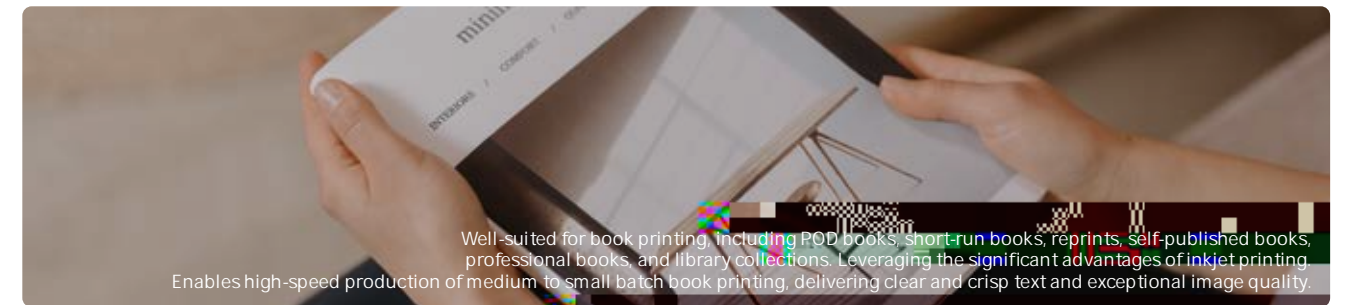

Well-suited for book printing, including POD books, short-run books, reprints, self-published books, professional books, and library collections. Leveraging the significant advantages of inkjet printing, enables high-speed production of medium to small batch book printing, delivering clear and crisp text and exceptional image quality.



Fast printing of documents such as bidding documents, Government correspondence, design institute materials, annual reports for listed companies, and more. Clear, sharp text and a professional layout with our solution, ensuring accurate reproduction of intricate details for visually appealing and high-quality printed output.



Instruction manuals, invoices, direct mail brochures, promotional leaflets, and large-scale commercial printing. Vibrant images, saturated colors, and sharp small text.

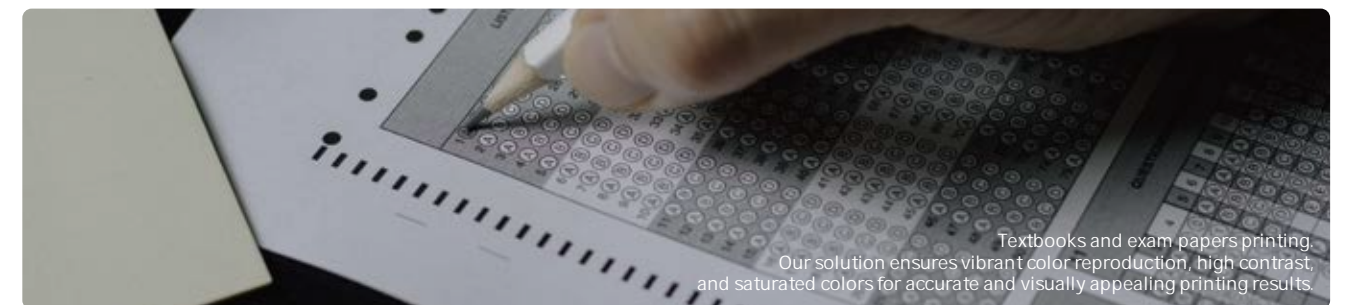

Textbooks and exam papers printing. Our solution ensures vibrant color reproduction, high contrast, and saturated colors for accurate and visually appealing printing results.

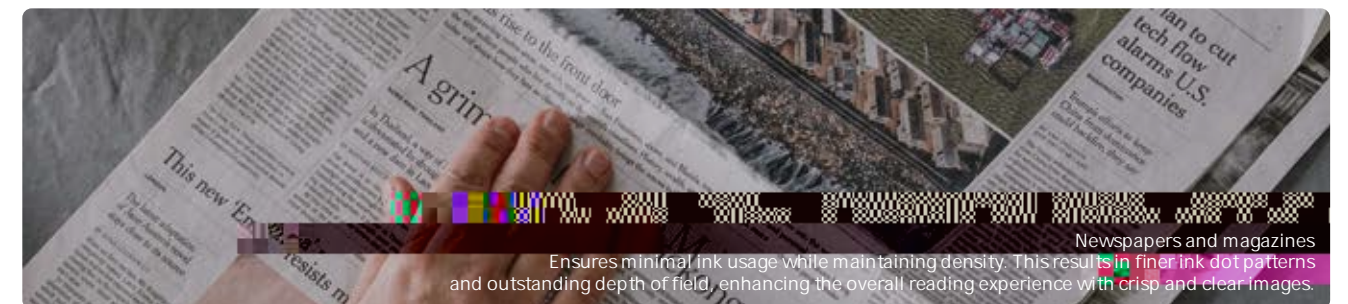

Newspapers and magazines. Ensures minimal ink usage while maintaining density. This results in finer ink dot patterns and outstanding depth of field, enhancing the overall reading experience with crisp and clear images.

Provide comprehensive end-to-end solutions that cover the entire printing process.

- Printing Width: 350 - 584 mm
- Max. Print Speed: 150m/min
- Color Configuration: Front and Back (Monochrome, 2 Colors, 4 Colors (CMYK))
- Printhead Configuration: 1200 DPI
- Inks: Water-based Pigment CMYK



Next Generation 1200 DPI Inkjet Technology

Next-generation 1200DPI offers higher resolution and more accurate representation of details in images and text compared to the 600 DPI technology. It delivers vivid image quality, texture, and color reproduction, setting a new benchmark in high-speed inkjet printing.

Ink Circulation within the Printheads

- Effectively prevents ink clogging issues, ensuring stable and continuous inkjet production. It also helps extend the lifespan of the printhead by reducing the risk of nozzle blockages. As a result, it minimizes maintenance time and costs associated with printhead cleaning to improved productivity and cost-efficiency.

Nozzle Compensation Technology

- Nozzle compensation to independently adjust and correct slanted or broken lines caused by nozzle clogging. This ensures precise and exquisite printing results with accurate reproduction of every detail, enhancing print quality and ensuring a smooth printing process.

High Temp Operation Sustainability





- The next generation printhead adaptability, allows it to operate effectively even in demanding conditions such as full-load operation in the drying module. Meet the requirements of 24-hour continuous production. No additional water cooling is needed and also to ensure stable registration, minimal color deviation, and reliable performance throughout the printing process.

Excellent Color Management Capabilities

- Color management system ensuring the consistency between the soft proofing on the screen and the actual printed colors.
- This guarantees the accuracy and consistency of colors for reprinted materials within the same batch.

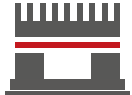

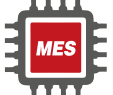
Industrial Digital Printing Solution Provider

<p>Independent printhead-drive technology</p> 	<p>Self-developed control system</p> 	<p>Self-developed MES system</p> 	<p>Independent ink industrial chain</p> 	
---	--	--	---	---



The HanGlobal Books and Magazines DFE (Digital Front End) Offers Several Software Advantages that Enhance Your Printing Workflow

Prepress Processing

Automated file normalization checks and preview adjustments ensure that files meet printing standards and achieve the desired print outcome.

High Automation

One-click layout for various post-processing techniques such as saddle stitching, stacking, perfect binding, and hardcover binding, reducing manual effort, increasing efficiency, and minimizing errors.

One-click Annotations

Flexibly add various types of annotations as needed. One-click addition of annotations such as cutting marks, registration marks, folding marks, labels, text annotations, variable data markers, rectangles, lines, and custom markers, aiding post-processing accuracy and workflow efficiency.

Powerful Color Management

Our software features a powerful color management system that ensures accurate and vibrant color reproduction. With spot color calibration and ink optimization capabilities, users can fine-tune colors to achieve precise and consistent results. This not only enhances the quality of prints but also saves costs by optimizing ink usage.

Strong Compatibility

No loss, misalignment, or redundancies in file handling strong compatibility, avoiding any issue of missing content, misplacement, or unnecessary elements when working with large files.

Rich Templates

Our software comes with a variety of pre-built layout templates that cater to general printing requirements. Users can also customize and save layout templates according to their specific needs, expanding their application possibilities.

Intelligent Order Management

Users can easily add, insert, or delete orders, and manage print queues. The software provides an order management system that enables real-time viewing, categorizing, filtering, and searching of order status and progress, ensuring efficient production control.

Sharp Edges on Text

For publications that require higher text quality, such as books and magazines, the software offers text edge sharpening to enhance clarity and sharpness, effectively reducing blurriness or roughness along text edges and improving readability.